

# **Stand-alone access control panel U-Prox CLC**

Instruction manual



**About this document**

This manual cover installation, adjustment and use of U-Prox CLC (hereinafter panel) stand-alone single door access control panel. Read this manual carefully prior to installing the system.

Characteristics, intended use and parameters of the panel are described in the section "Summary". Section "Terms" provides an explanation of terms found in this document. The look of the panel, the pins and the mode of work are described in the "Description" section. Order of installation, adjustment of external devices and panel configuration are described in the "Working with the device" section.

**Attention!** Read this manual carefully prior to installing the system. Installation, adjustment and utilization of panel is allowed only by persons or organizations with the appropriate authority from the manufacturer

**Technical support**

To get warranty and technical support you can apply to authorized service centers, situated in the territories or countries listed in the warranty card.

Warranty and technical support are performed in the territory or the country where the customer applied for warranty or free service.

Technical information is available on the system website [www.u-prox.com](http://www.u-prox.com)

## Contents

Brief description of the panel .....	4
Intended use.....	4
Summary .....	4
Description and operation.....	5
Panel.....	5
Panel terminals assignment .....	5
Enumeration of panel modes .....	6
Panel operation .....	6
ID entry (card pass) to connected reader.....	6
User codes.....	6
Durations .....	7
Entry/exit duration.....	7
Panel operation modes .....	7
Panel programming .....	8
Mobile ID (U-Prox ID) .....	20
How to user receive U-Prox ID.....	22
How to work with the device .....	24
Installation recommendations .....	24
Installing Panel .....	24
Connecting an external reader.....	24
Loops connection .....	25
Request to Exit button (REX) .....	25
Door Contact.....	25
Actuators .....	26
Electric locks.....	26
Alarm output .....	26
Panel programming sequence .....	27
Maintenance.....	27
Factory reset.....	27
Switching to programming mode.....	27
Factory settings .....	27
Terms.....	28

## Brief description of the panel

U-Prox CLC panel - a standalone device designed to control access to residential and business premises.

U-Prox CLC panel provides control of one actuator. It controls access into a room with one door using one reader (single-sided door).

U-Prox CLC processes the information received from the reader and unlocks the door driving actuator with a built-in relay.

An external U-Prox SL (Smartline) reader should be connected to the panel.

Panel can be adjusted with smartphone in standalone operation mode. Adjustment includes access rules configuration, ID list edit, full panel operation adjustment.

U-Prox CLC panel has terminals for Request to Exit button and Door contact.

## Intended use

U-Prox CLC panel is designed for operation in standalone operation mode and provides access into one room, controlling entry.

## Summary

- Standalone mode
- Power supply +10.8 - +15 V
- Power consumption less than 160 ma @12V
- Maximal power source voltage ripple 500 mV
- Connection U-Prox Smartline reader
- Door Contact terminal
- Request to Exit button terminal
- Open/remove tamper
- One relay with NO, NC, COM terminals 3A @ 12V
- Alarm output. Open collector 24V, 60mA
- Adjustment from the smartphone
- Real time clock
- Nonvolatile memory:
  - 254 user IDs,
  - 1000 events
  - "Day" and "Night" modes
- Dimensions – 120x66,5x25,5 mm
- Weight – 0.13 kg

## Description and operation

### Panel

The look of the access control panel is shown in Fig. 1

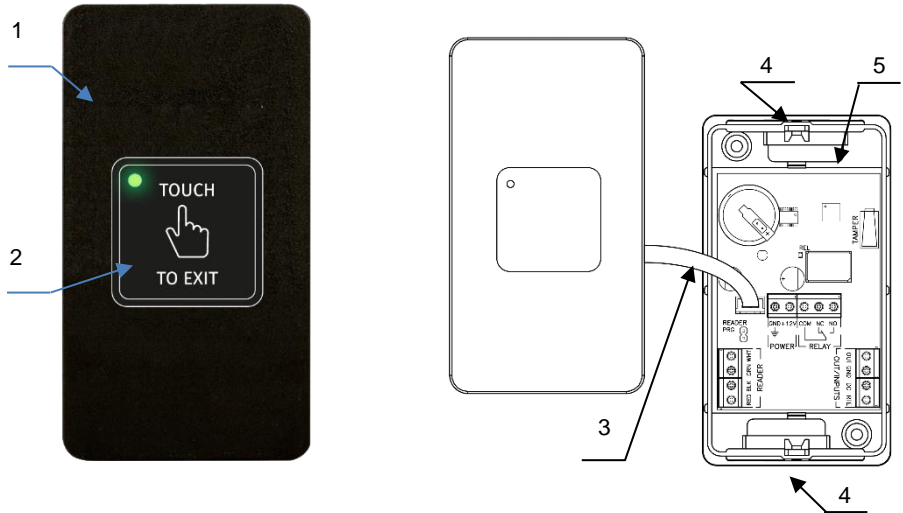

- |   |   |
|---|---|
| <ol style="list-style-type: none"> <li>1. Panel enclosure</li> <li>2. Built-in REX touch button with LED confirmation</li> <li>3. Connection cable</li> </ol> | <ol style="list-style-type: none"> <li>4. Nuts for fixing screw. Bottom may turn on 180 grad at mounting</li> <li>5. Panel mainboard</li> </ol> |
|---|---|

Fig. 1. U-Prox CLC panel view

### Panel terminals assignment

<i>Terminal</i>	<i>Description</i>	<i>Assignment</i>
GND		Power supply connection
+12V		
NC	<b>Normally closed</b>	Relay contacts
NO	<b>Normally open</b>	
COM	<b>Common</b>	
RED	<b>Reader power +12V</b>	Reader connection
GND	<b>GND</b>	
GRN	<b>Data 0</b>	
WHT	<b>Data 1</b>	
OUT	<b>Programmable output</b>	
GND	<b>GND</b>	Inputs
DC	<b>Door contact</b>	
RTE	<b>Request to Exit button input</b>	
OUT		Alarm output
PRG jumper	<b>Switch reader in programming mode</b>	

**Enumeration of panel modes**

Current panel access modes indicated by readers connected

<b>Operation mode</b>	<b>Readers' annunciation</b>
Normal mode	No sound, Red blinks once per second
Night mode or Panel blocked	No sound, Red and Amber alternate once per second
Alarm	No sound, Red light on continuously
Card enrolment	No sound, Green blinks once per second
Panel startup	No sound, No lights
Upload or Download	Short clicks in standby mode, no sound, Red light on continuously
Access granted	One beep, Green light on continuously. In 5 seconds prior door relock, beeps every second
Access denied	Long sound, Red light on continuously
<b>REX Button LED indicate only button pressing!!!</b>	

**Panel operation**

The panels are supplied unconfigured. Settings are outlined below. In this state Red blinks once per second.

For panel configuration download the program settings from U-Prox Mobile Config software.

Panel switches into the Normal operation mode if inputs are safe and settings are downloaded into the panel.

**ID entry (card pass) to connected reader**

Press keys on the keypad sequentially to enter the code. The length of the code must be not less than four digits and not more than ten digits. Finalize code entry with [#] key press. Buzzer beeps on each key press. Correct entry is confirmed with one short beep. Entry error or unknown code entry is followed with one long sound.

Keypad blocked after several sequential wrong (unknown) codes entry or RF ID passes. This function is inactive by default.

Press [\*] key to cancel erroneous key sequence.

The key sequence is erased and panel returns to Normal mode after 40 seconds pause in entry.

RF ID pass equivalent to the key entry. Panel accepts both ASK RF ID's and FSK ID's.

Built in reader reads cards and accepts codes both in Normal mode and in Program mode.

Built in reader reads RF ID's. Beside this, external reader connection is possible; In this case a panel situated within secure premises.

U-Prox ID mobile application allows use of smartphone or tablet as ID.

**User codes**

These codes can:

- Drive relays,
- Switch panel into night operation mode and vice versa

Administrator can adjust code category and options for each code individually.

- Code category defines the access mode.
- Code options define numbers of relays driven with code, relay duration and entry/exit duration.

### **Duress code**

Each user has an additional “duress” access code independent of code category.

Panel performs all actions, programmed for normal user code and activates Alarm output on duress code entry.

Users’ own RF ID’s or Mobile ID’s do not have an additional duress code.

Duress code differs from normal code by one in the last digit. For example, if normal code is **[1] [2] [3] [4]**, then duress code will be **[1] [2] [3] [5]**.

If last digit of normal code is [9], then duress code ends with [0]. For example. If normal code is **[2] [0] [0] [9]**, then duress code is **[2] [0] [0] [0]**.

### **Durations**

#### **Default durations**

Panel has default durations for ease of panel adjustment. These durations are “Relay duration” and “entry/exit duration”.

One may set default values of durations for each code’s parameters. Changing this value changes the corresponding parameter for all codes with durations that are currently set to default.

Example. The value of 255 is set automatically to relay duration for each newly created code, which means, that the default value is used (factory setting 3 sec). If somebody sets relay duration value 255 to several codes, it will mean that these codes will have default relay duration. It is enough to change the default relay duration to change the relay duration for the above mentioned codes if necessary

#### **Entry/exit duration**

The entry/exit duration countdown starts after relay activation. The countdown stops after the first violation with subsequent restore of the door contact. The buzzer starts beeping in 5 seconds before entry/exit delay exhaustion if door remains open to warn user about this. Close the door and enter code once more to extend duration. Entry/exit time is programmable. Allowed values are 0 to 253 seconds.

#### **“Opened door” mode**

Door position (opened or closed) not supervised if code with entry/exit duration value 254 entered until the door contact state not changed to opposite.

#### **Keypad blocking**

Panel blocks keypad and reader for programmed time if wrong code or unknown RF ID entered three times consecutively to prevent the code or RF ID matching. The Keypad blocking time allowable values are 0 to 255. Zero value means that keypad blocking mode is off.

#### **Panel operation modes**

Panel operates in several modes:

- - normal day mode,
- - normal night mode,
- - programming,
- - keypad and reader blocking.

LED blinks Red in normal day mode. Panel performs programmed actions on RF ID pass or code entry in this mode. The actions could be Relay activation and a switch to day/night mode.

LED alternately blinks Red and Yellow in normal night mode. The difference from day mode is that only codes and RF ID's of category "Day and night" are active in this mode.

Panel is switched from night mode to day mode and vice versa automatically by schedule or manually with code not having the right to control any relay. Such code must be assigned the category "Day and night", because if it is assigned another category it will be possible to switch panel into the night mode to the possibility to return to day mode.

Panel performs all actions, programmed for normal user code and activates Alarm output for programmed time on duress code entry. Alarm output activates immediately after code entry. If there was no any keypad activity, panel will return to normal mode in 40 seconds.

### Panel programming

Download and install U-Prox Config application.

Mobile devices with Android 5.0 OS and higher, Apple IOS 8.0 and higher supported.



Run U-Prox Config application

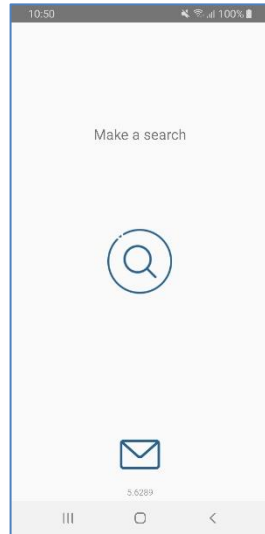

Press "Start" button on application. Application will search for devices.

**Attention! The location services must be ON in Android 6.0 and higher**  
Panel name displayed at scan.





Select panel from the device list and press 'Connect'  button. Enter engineer's code - application will read out panel settings.

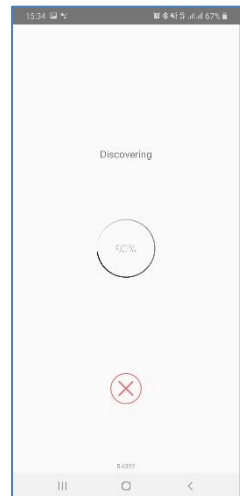

Access denied message displayed on attempt to connect without authorization.

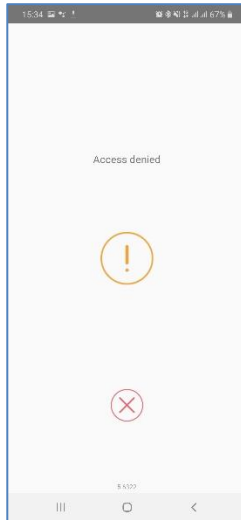

The main menu will activate after the settings readout. Advanced options displayed after 'More' button pressed.

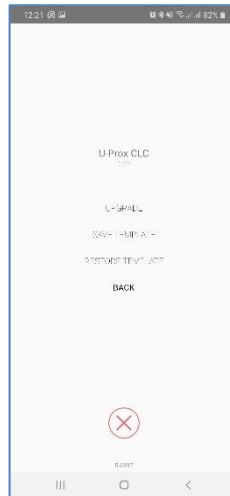

The menu item 'Save To Device' becomes active after settings adjustment. Select 'Save To Device' to save changes.



Press 'Disconnect'  button to break connection with panel.

**Attention!!! Disconnection without writing settings will cause loss of changes.**

**'Settings' menu item contains the main panel settings:**

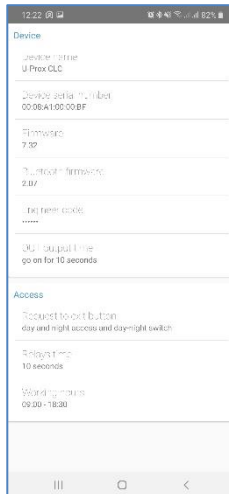

### “Device” settings group

“Device name” – panel name setting

“Firmware” and “2.4 GHz radio firmware” – firmware version and upgrade

“Engineer’s code” – engineer's code change

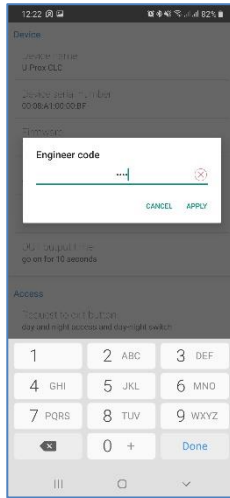

*New code accepted if it is not equal to any other code in system, including duress codes.*

**“OUT”** – alarm output activity duration  
 Allowed values 0 to 240 seconds

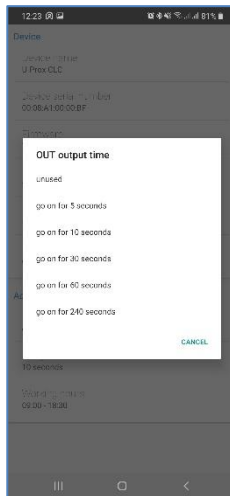

**“Access”** settings group

**“Request to exit button”** – REX operation modes:

*“day and night access” – input RTE active always*

"day and night access and day and night mode switch" – long REX press alters day and night panel modes

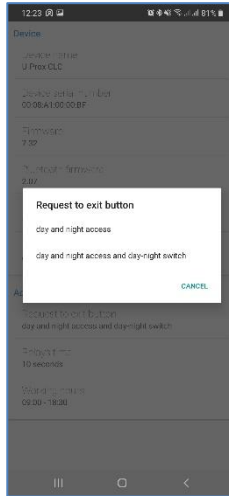

"Default Relay time" – settings of default duration of Relay activation  
 Allowable values 0 .. 254 seconds. Zero value used for relay trigger mode

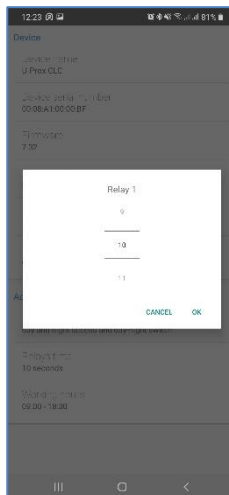

"Working hours" – Night/Day mode automatic switch schedule. Panel is in day mode inside period of time set and in night mode outside it. Manual switch by passing ID

with appropriate option between Night and Day modes possible only if automatic change mode is Off.

*Panel starts to beep every second from one minute before automatic switch into Night mode and beeps 2 times every second from 20 seconds before switch.*

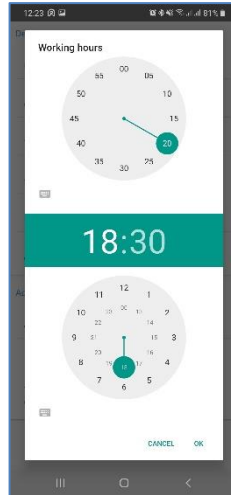
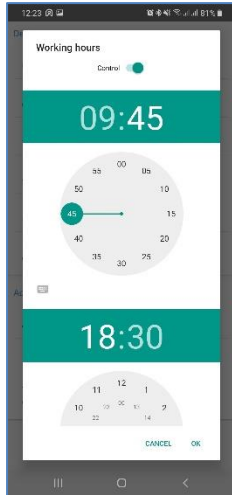

Press ◀ ("Back") to exit "Settings" menu

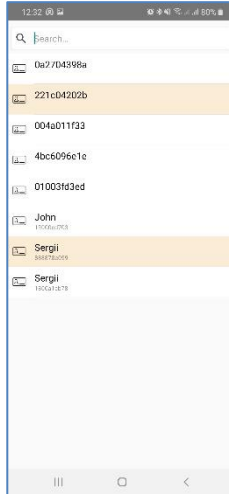
**'Access' menu item contains the list of codes enrolled in panel:**

Each list entry contains:

- Access type: day – white background, day and night – orange background, or without access – gray background
- Code name (or numeric value of the code if name was not set)

**To remove code** from the list, swipe it from right to left. Element is marked as removed. To restore it press "UNDO".

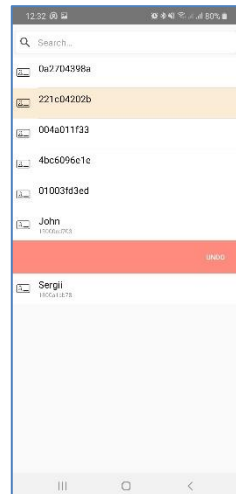
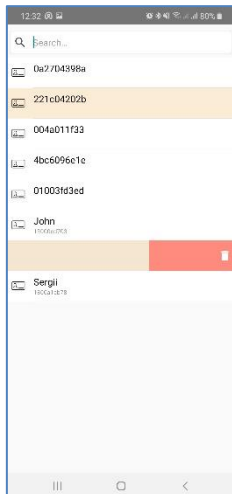

**To enroll new RF ID** pass RF ID to the reader. This action adds RF ID to the list of ID's with default settings.

**To enrol new keypad code** enter it from the keypad finalizing finalising with [#] key. This action adds RF ID to the list of ID's with default settings.

**To enrol new mobile ID** pass smartphone with U-Prox Mobile ID app (with licensed U-Prox ID) to the reader and press  button in app.

**To change settings for code** select it in the list. The settings window will open. Change card name and settings. Press 'Apply' to save the changes.

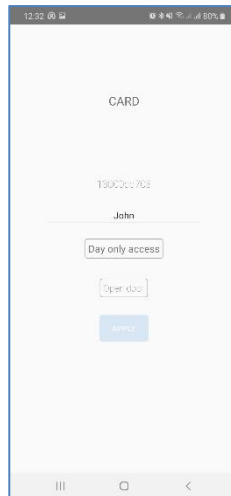

It is possible to set personally for each identifier:

- *access type*

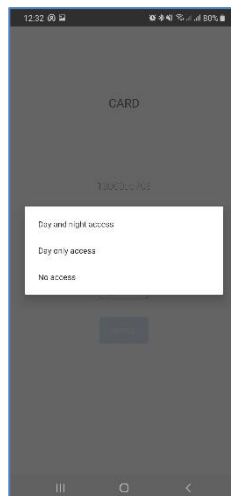



- action type after the ID pass



Press "Apply" button to save changes.

**To change settings for several IDs** select the first of the identifiers in the list, click on it and hold until it is highlighted in color. Select other identifiers. Next, click  - the settings window will open. Change cards settings.

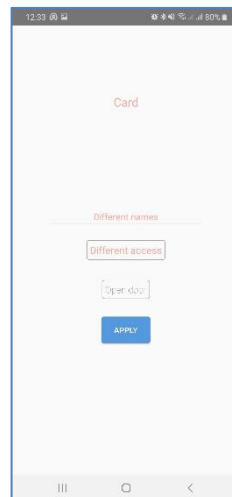

Press 'Apply' to save the changes.

Press < ("Back") button to exit "Access" menu item

**To view the event log use “Log” menu item:**

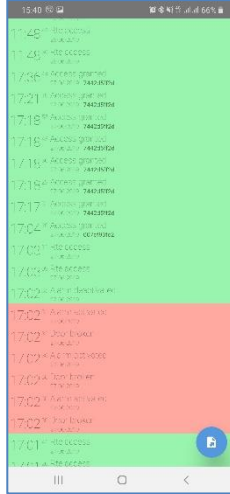

Press **B** button to export log.

Press < (“Back”) button to exit “Log” menu item

**Use “Upgrade” menu item from advanced options to upgrade panel firmware.**  
The list of available files in \*.bin format are displayed after this item is selected.  
Firmware upgrade process will start after desired file selection.

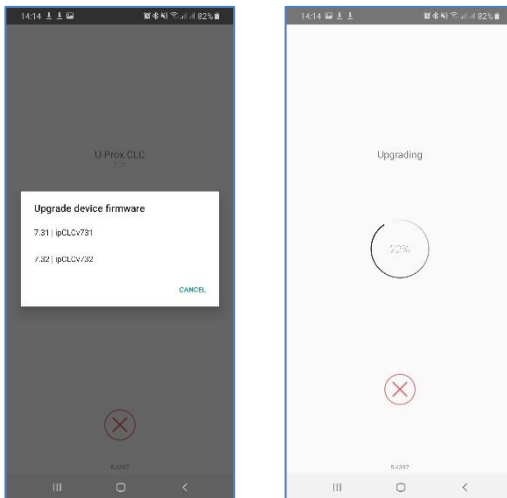

***Attention!!! All files with firmware must be stored in “Download” folder in main mobile device memory.***

**Panel settings save and restore available from “Save” and “Restore” menu items of the advanced options.**

All settings are saved into the file with \*.eep extension in Download folder in main memory of the mobile device.



The list of available files with settings will display after “Restore” menu item selection. Select one of them to restore settings into the panel.

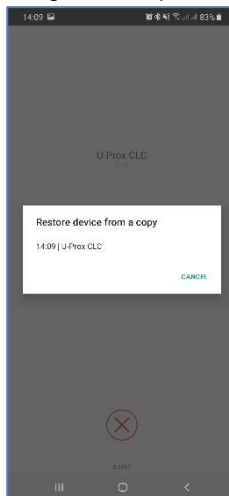



### Mobile ID (U-Prox ID)

Download and install U-Prox Mobile ID application.

Mobile devices with Android 5.0 OS and higher, Apple IOS 8.0 and higher supported.

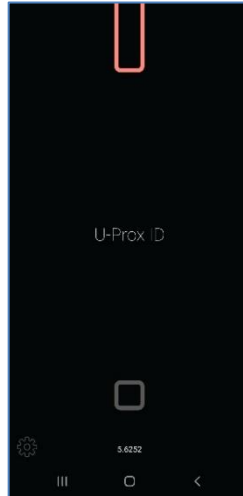
Run U-Prox ID application.



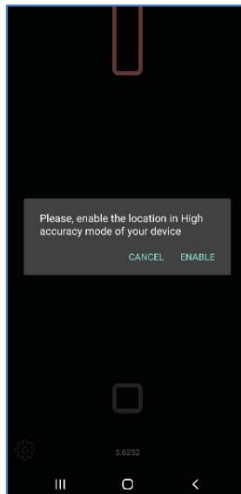

Press  button in application –will exchange data with application. Application will request permissions for operation.

***Attention! The location services must be ON in Android 6.0 and higher for operation***

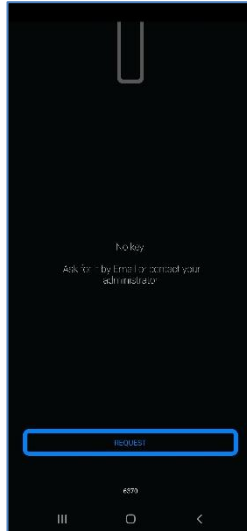

*Attention! Button in application will be inactive until U-Prox ID is received*



Pass smartphone with U-Prox Mobile ID app to the reader and press  button in application – will exchange data with application. Panel will grant access if the code has been enrolled and has correct access rights. Panel and application indication will change.

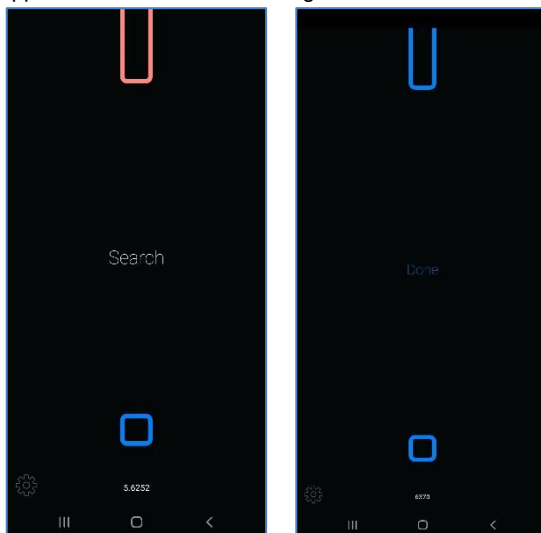

Often, smartphone unlocking is protected by a PIN code, a pattern, or a fingerprint and it is not convenient. So, you can use NFC connection or "Access on turn on screen" mode.

How to use "Access on turn on screen" mode:

- Bring your smartphone to the reader at a sufficient distance
- Turn on the screen of the smartphone – reader will exchange data with application.

This method can be used for the "Door- Proximity", "Door" reader modes.

To use this method for "Barrier/Gate" reader mode you have to turn off option "Access from application only" in the reader.

If option "Access from application only" is turned on for "Barrier/Gate" reader mode you must unlock smartphone, run U-Prox Mobile ID app and press  button.

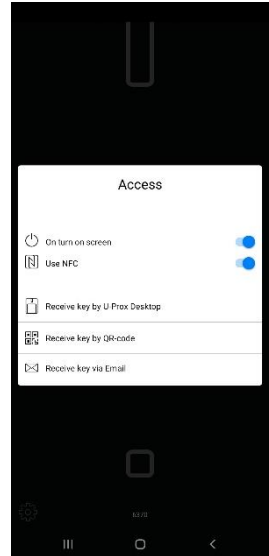

To activate "On turn on screen" mode, click  icon - settings will open. Turn on the "On turn on Screen" option and press the "<" button.

**How to user receive U-Prox ID**

The U-Prox ID mobile ID should be added to the U-Prox Mobile ID application before being stored in the controller's memory.

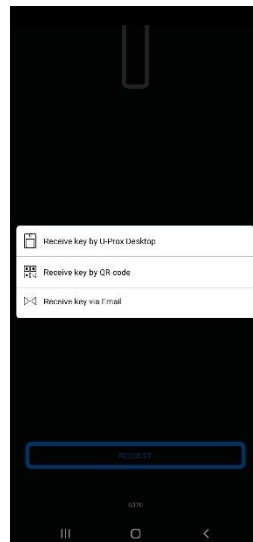
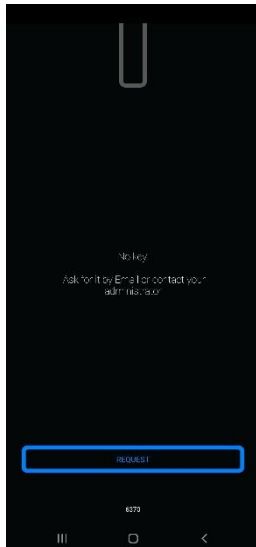

**This can be done as follows:****By QR code**

The user reads a one-time QR code or loads it from a graphic file to U-Prox Mobile ID application.

Using the information (link) from this QR-code, the application gets a unique mobile credential from the bank of credentials on the cloud server.

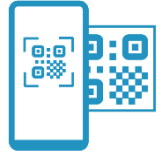
**From U-Prox Desktop over 2.4 GHz radio**

1. The system administrator switches U-Prox Desktop into "issue mobile credentials" mode.
2. The user runs the U-Prox Mobile ID app, clicks "Get ID from U-Prox Desktop" and brings the smartphone to U-Prox Desktop.
3. Desktop issues a unique mobile credential and marks it as issued.

**From U-Prox Desktop by E-Mail**

1. User from U-Prox Mobile sends an e-mail request to receive U-Prox ID to ACS administrator. A special link will be created in the text.
2. Administrator receives the email, then clicks this link in the e-mail and loads the request data into the engineering application.
3. Next, the administrator switches U-Prox Desktop into the "issue mobile credentials" mode and connects to it with the engineering application.
4. Administrator processes the request, obtains a credential from U-Prox Desktop and sends it by e-mail to user in the engineering application.
5. User opens the link from the e-mail with U-Prox Mobile ID app and obtains a mobile credential U-Prox ID.

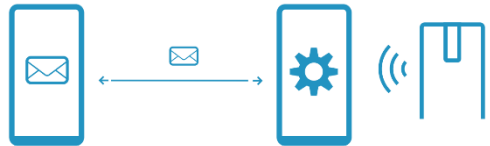

## How to work with the device

Panel placed into the small plastic enclosure. Dimensions are in Fig. 2.

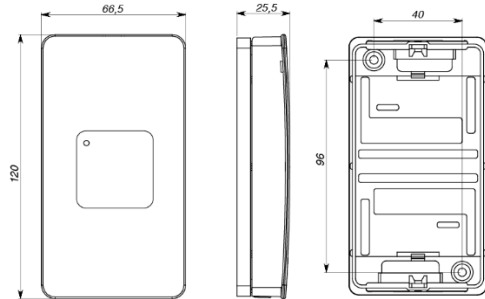

Fig 2. Dimensions

### Installation recommendations

1. Prepare the place of panel mount – mark and drill holes:
  - a. Loosen the screw at the bottom of panel
  - b. Take off cover, disconnect the cable from base.
  - c. Mark the hole positions on the place of mount, using base as template. Drill two holes 5 mm in diameter and 30 mm depth.
2. Run cable from the power supply
3. Run cable from the actuator (lock)
4. Install reader and run its cables
5. Proceed Door Contact and REX wiring
6. Connect all wires from power supply, lock, reader, door contact and REX according to the information below.
7. Place the installation cables in the wall
8. Place and fix base, connect the cover with connection cable, close and fix it with screw.
9. Adjust and download settings with mobile application.
10. Panel is ready for work

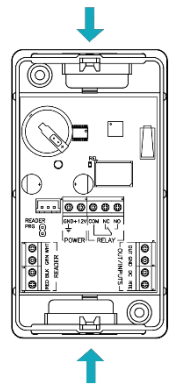

Fig. 3. Cable run

### Installing Panel

Panel should be installed on the wall next to the door for users to easily press REX button.

Power cables and other cables should not be located less than 0.1m from the panel enclosure.

Cables may run both from the top and from bottom of the panel.

### Connecting an external reader

The reader should be connected to panel. Only U-Prox SL (SmartLine) series reader may be used with panel as external. The connection is depicted in Fig.4.



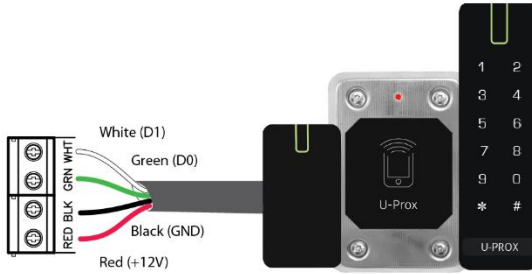

Fig. 4. Reader connection

Current consumption of reader connected to terminals "12V" should not exceed 100mA. When connecting a reader of long range to the panel with a current consumption of more than 100mA, supply the voltage to it from the separate source.

Use **PRG** jumper to change reader settings with smartphone without engineer code input.

**Depower the panel before set or remove PRG jumper!!!!**

**Loops connection**

Panel has two inputs for connecting the loops supervised with end of line resistors. Each input functionality is programmable. Input functions are:

- Door Contact
- REX button (RTE input)

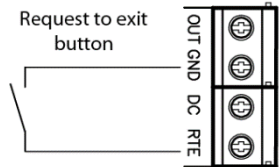

Fig. 5. REX button connection

**Request to Exit button (REX)**

REX is used for exit through single-sided door. In this case, access point opens when you press and release REX. Use this input type for remote door opening button connection also. For example, to open the door manually, by a security guard. An example of normally open contact REX button connection to RTE terminal is on the Fig 5.

The use of button of the electric lock to open access point or "allow access" button on the turnstile invokes the "DOOR FORCED OPEN" event.

**Door Contact**

Control panel supervises the door state or position of the turnstile rotor with the door contact. Panel cannot detect unauthorized access or door is open too long (multiple entrance with one ID for instance) without the Door Contact.

The example of normally closed door contact connection to DC terminal is in Fig.6:

The control panel can operate without the door contact.

In this case, after the passing RF ID for identify and granting access, the control panel sends unlocking impulse, and returns to normal mode after lock time expiry.

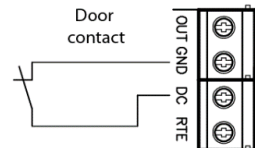

Fig. 6. Door contact connection

**Actuators**

Panel has one relay to supervise actuator. Using output, panel controls electric locks or latches, operation of the barrier, or turns on any optional hardware.

Relays normally closed and normally open contacts. The relay contacts rating is 3A @ 12V.

Do not use diodes with actuators connected to the source of alternate voltage.

Voltage ripple at actuator operation must not cause the panel malfunction. In case of such malfunction power up actuators from alternate power supply.

**Electric locks**

Normally closed and normally open relay contacts are programmable for a wide range (0 ... 255 sec) of lock operation time. Panel controls electric lock or latch, barrier operation, turnstile, or turns on and off any optional hardware with this output.

When the lock time is equal to 0 pulse duration of 200 ms is sent to the relay.

Examples of the actuator connection is in Fig. 7. The first is powering the lock and second by depowering.

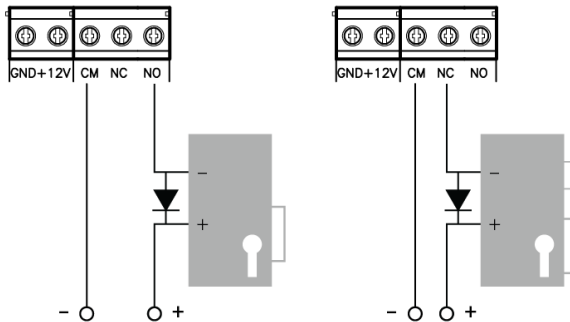

Fig. 7. Locks connection

When using relay to turn on / off current via inductive load, eg. to run electromagnetic lock, there are electric pulses of high amplitude. To prevent damage of relay contacts, shunt inductive load by diode, set in opposite direction to voltage of coil supply.

Remember, that low-cost solenoid latch does not allow long power supply. For these latches program the lock time as short as possible to prevent coil overheating.

Do not use diodes with actuators connected to the source of alternate voltage.

Assign relay outputs as outputs of locks at panel programming for proper operation.

**Alarm output**

Alarm output is open collector. ALM shorts to GND when output is active. You may connect alarm output for connection to the alarm system or actuator with less than 60mA consumption.

Alarm output is active during 'Alarm' mode.

**Panel programming sequence**

1. Connect to panel and enter engineer code
2. Adjust panel from mobile application:
  - a. Entry/exit duration adjustment
  - b. Outputs adjustment: type and durations
3. Enroll RF IDs and edit users with their access categories.
4. Panel is ready for use after download.

**Maintenance****Factory reset**

To return panel to the factory settings, perform the following steps:

1. Depower the panel
2. Remove top cover of panel
3. Short OUT and RTE terminals
4. Power up
5. Wait for six beeps, signaling the successful panel reset
6. Disconnect panel and remove short from OUT and RTE terminals

**Switching to programming mode**

To put panel into programming mode, do the following:

1. Depower the panel
2. Remove top cover of panel
3. Short OUT and DC terminals
4. Power up
5. Connect with U-Prox Mobile Config
6. Disconnect panel and remove short from OUT and DC terminals

**Factory settings**

Master code – 1234

Engineers code - 5678

Entry/exit duration – 20 seconds,

Code matching blocking duration – 40 seconds

Inputs: RTE – '*day and night access*' mode, OUT - disabled

Outputs: Relay – 3 seconds, OUT (alarm) – 10 seconds

## Terms

### Identifiers

In access control systems each user has a unique RF ID. Identifiers can take the form of a plastic card, key FOB etc.

### Reader

The information on the identifiers is read with READERS, connected to the ACS control panel. There are several types of RF IDs and readers for them. It is essential that reader and control panel use the same interface. Only U-Prox SL series readers may be connected to the U-Prox CLC control panel.

### PIN (Personal Identification Number)

Some readers have built-in keypad. Keypads may be used for PIN entering. It can be both self-dependent or used as an additional code to user RF ID. When PIN is programmed as additional code, reader waits for PIN entering after RF ID is read-out.

### Access point

Access point is a logical concept of the access control system implying control of passing through a door in one direction. It consists of reader, access control panel (or its part), door supervision devices (like door contact, REX button etc.) and door locking device. For instance, the turnstile with two-way passes has two Access points – one for entrance and the other one for exit, door of this type is called double-sided door. A door with a reader on one side has only one Access point – Entry point, and it is called single-sided door.

### Direction of passage

Passageway - is a logical unit of ACS, controlling passage through the access point in one direction. It includes reader, access control panel (or part of access control panel), actuator. So, tourniquet with double-sided control has two passageways, and the door, having single-sided reader - only one passageway. Access point, which consists of two passageways, is called double-sided, and the point of access, which consists of one direction of passage - single- sided.

### REX (request to exit)

To exit from the premises with a single-sided door, a button wired to control panel is used. This button is called REX (request to exit) button. If someone opens a door otherwise than pressing REX button – by re-energizing locking device, opening lock with a key etc., "Door Forced Open" event arises. REX button may be used for remote door opening as well.

### Door Contact

A properly designed ACS has to supervise door status (opened or closed): magnetic door sensor, sensor of the turnstile rotor position, inductive sensor of the road barrier, etc. This ensures that the system prevents situations when several users access the door with one RF ID or the door is left open after user's access and so on.

For these purposes the magnetic door sensor, the turnstile rotor position sensor and the position sensor of boom barrier are connected to the input of panel. The input used to connect the sensors, is called the input of the door contact.

### Antipassback

Antipassback function is implemented in access control panels to prevent the situation when user gives his RF ID to another person after passing into the premises. If this

function is on, control panel tracks an RF ID position – inside or outside the premises. On any attempt to pass in the same direction twice the panel denies access and stores “Access Denied, Antipassback” event into the Log.

Antipassback function can be set on only in case of the double-sided door control.

**Door time**

If door sensor is open, corresponding access point goes into alarm. Alarm is not invoked, if contact is opened during Door Time interval. This interval starts when access is granted and lasts for the programmed time or terminates on opening and subsequent closing of door contact.

**Code matching attempt**

Control panels can activate alarm on attempt of a code (or RF ID) matching. Code matching is considered when invalid code (or RF ID) is entered several times successively. Valid code entering clears the counter. This function switching On and number of code entrances are subjects of programming.

**Downloading**

Control panel is to be downloaded after all parameters are set – modes of inputs, outputs, access rights and others. During downloading parameters are rewritten into access control panel.